



REFERENCIA	APLICACIÓN
 <p>7697-D825-FMSI-MT</p>	<p>NKR 1998-2012 EJE DELANTERO / HINO 300 MODELO XZU: 710-HK-FRP (2011-)</p>

GRÁFICO	CARACTERÍSTICAS
	<ul style="list-style-type: none"> • Compuesto semi-metálico HD • Excelente durabilidad • Libre de asbesto 100% • Diseño OEM

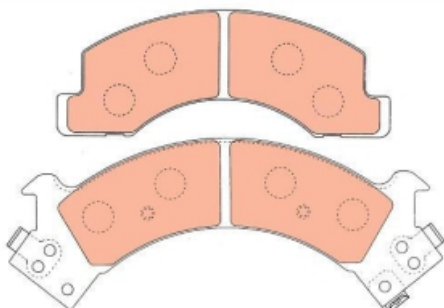

REFERENCIA		APLICACIÓN
	7425-D546-FMSI-MT	NPR 1992- EJE DELANTERO

GRÁFICO	CARACTERÍSTICAS						
 <table border="1" data-bbox="194 1596 560 1649"> <tr> <td>183.3</td> <td>49</td> <td>22</td> </tr> <tr> <td>240</td> <td>49</td> <td>22</td> </tr> </table>	183.3	49	22	240	49	22	<ul style="list-style-type: none"> • Compuesto semi-metálico HD • Excelente durabilidad • Libre de asbesto 100% • Diseño OEM
183.3	49	22					
240	49	22					



REFERENCIA		APLICACIÓN
	ICH-0004-MT	VW CRAFTER 35 2.0 TDI 4 EMOTION RUEDA SENCILLA (2020-) EJE DELANTERO
	ICH-0004-CM	

GRÁFICO	CARACTERÍSTICAS
	<ul style="list-style-type: none"> • Compuesto semi-metálico HD • Compuesto cerámico Ichimax • Excelente durabilidad • Libre de asbesto 100% • Diseño OEM • Ref OEM - 2N0698151 / 22147 / 9483-D2247



REFERENCIA	APLICACIÓN
------------	------------

	ICH-0003-MT	VW AMAROK 2.0 TRENDLINE / COMFORTLINE / HIGHLINE / V6 (2HA, 2HB) 2.0L TURBODIESEL / VW CRAFTER 35 2.0 TDI 4 EMOTION RUEDA SENCILLA EJE TRASERO
	ICH-0003-CM	

GRÁFICO	CARACTERÍSTICAS
---------	-----------------

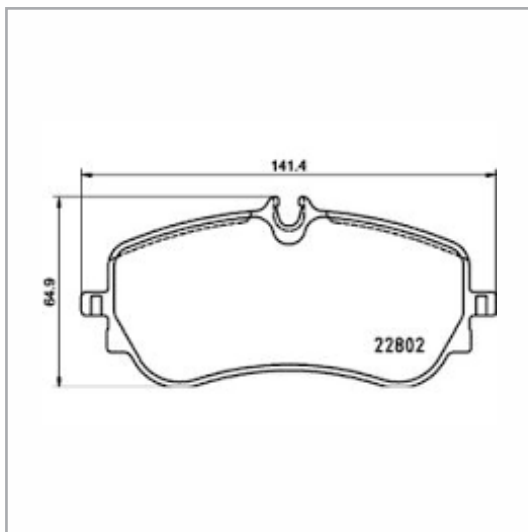

- Compuesto semi-metálico HD Ichimax
- Compuesto cerámico Ichimax
- Excelente durabilidad
- Libre de asbesto 100%
- Diseño OEM
- Ref OEM - 2H6698451 / 2H6698451A



REFERENCIA	APLICACIÓN
 ICH-0001-CM	RENAULT KWID LIFE / ZEN / OUTSIDER 1.0 (2020-22) EJE DELANTERO

GRÁFICO	CARACTERÍSTICAS
	<ul style="list-style-type: none">• Compuesto semi-metálico HD Ichimax• Compuesto cerámico Ichimax• Excelente durabilidad• Libre de asbesto 100%• Diseño OEM• Ref OEM - 410602596R



REFERENCIA	APLICACIÓN
 <p>ICH-0002-CM</p>	<p>FAW R7 1.6 / X40 (2018-22) / BRILLANCE V5 SPORT (2015-18) EJE TRASERO</p>

GRÁFICO	CARACTERÍSTICAS
	<ul style="list-style-type: none"> • Compuesto semi-metálico HD Ichimax • Compuesto cerámico Ichimax • Excelente durabilidad • Libre de asbesto 100% • Diseño OEM • Ref OEM - D4033-SN100-YO

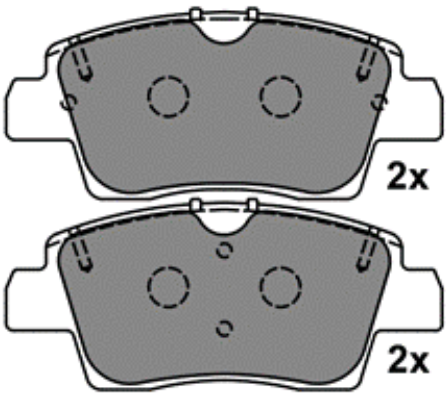

REFERENCIA	APLICACIÓN
<p>9081-D1852-FMSI-MT</p>	MAZDA 2 SPORT 1.5 PRIME / PRIME AUT / SPORT TOURING / TOURING AUT / GRAND TOURING 1.5 SKYACTIV / 2 HATCHBACK 1.5 (2020) / TOYOTA YARIS (2016-) (2017-18) EJE DELANTERO
<p>9081-D1852-FMSI-CM</p>	

GRÁFICO	CARACTERÍSTICAS
	<ul style="list-style-type: none"> • Compuesto cerámico Ichimax • Excelente durabilidad • Libre de asbesto 100% • Diseño OEM • Ref OEM - DAY53328ZA / DBY13328Z / DBY1-33-28ZA • DAY5-33-28ZA / 22235

PASTILLA DE FRENO



HD SERIES
HEAVY DUTY SERIES



REFERENCIA	APLICACIÓN
 9141-D1911-FMSI-CM	NISSAN NP300 FRONTIER D23 2.5 4X4 / RENAULT ALASKAN 2.5 4X4 (2018-) EJE DELANTERO

GRÁFICO	CARACTERÍSTICAS
	<ul style="list-style-type: none">• Compuesto cerámico Ichimax• Excelente durabilidad• Libre de asbesto 100%• Diseño OEM• Ref OEM - D10604KH0C / D1M60-4JA0A / D1060-4JA0A



REFERENCIA	APLICACIÓN
 9269-D2038-FMSI-CM	NISSAN KICKS 1.6cc (2018-20) EJE DELANTERO

GRÁFICO	CARACTERÍSTICAS
	<ul style="list-style-type: none"> • Compuesto cerámico Ichimax • Excelente durabilidad • Libre de asbesto 100% • Diseño OEM • Ref OEM -

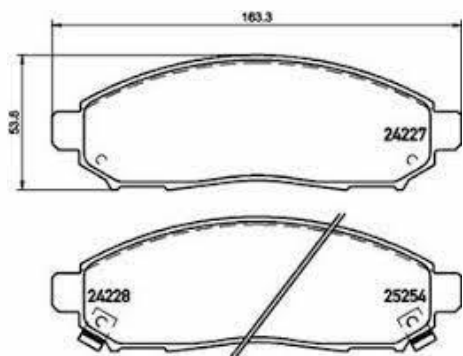
HD SERIES

HEAVY DUTY SERIES



REFERENCIA		APLICACIÓN
	96682858-MT	CHEVROLET SPARK GT 1.2 M300 / BEAT 1.2 LS / LTZ / PREMIER (2016-21) EJE DELANTERO
	96682858-CM	

GRÁFICO	CARACTERÍSTICAS
	<ul style="list-style-type: none"> • Compuesto cerámico Ichimax • Compuesto semi-metálico Ichiban • Excelente durabilidad • Libre de asbesto 100% • Diseño OEM • Ref ALTERNA - 8801-D1590 / 25268 / 10313 / SP1392

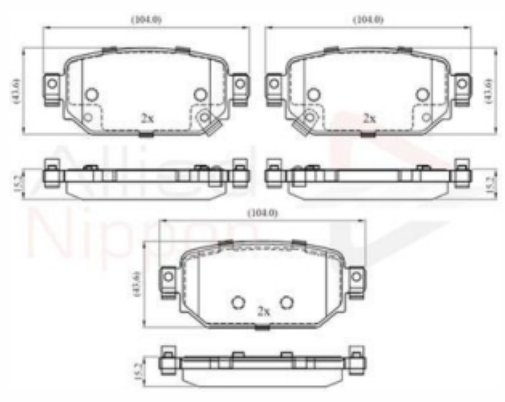

REFERENCIA	APLICACIÓN
 <p>9271-D2045-FMSI-CM</p>	<p>MAZDA 3 NEW SKYACTIV 1.6 - 2.0 (2017-2020) / Cx3 2.0 (2017-2020) MORDAZA ELÉCTRICA EJE TRASERO</p>

GRÁFICO	CARACTERÍSTICAS
	<ul style="list-style-type: none"> • Compuesto cerámico Ichimax • Excelente durabilidad • Libre de asbesto 100% • Diseño OEM • Incluye grasa lubricante sintética • OEM - BAY02643ZA



REFERENCIA	APLICACIÓN
 9144-D2019-FMSI-CM	CHEVROLET TRACKER 1.8 LT / LS / LTZ AT (2019-2021) EJE DELANTERO

GRÁFICO	CARACTERÍSTICAS
	<ul style="list-style-type: none"> • Compuesto cerámico Ichimax • Excelente durabilidad • Libre de asbesto 100% • Diseño OEM • Incluye grasa lubricante sintética • OEM - 42566753



REFERENCIA	APLICACIÓN
 9144-D2019-FMSI-CM	CHEVROLET EQUINOX 2018-2021 1.5 TURBO LS / LT (2019-2021) EJE DELANTERO

GRÁFICO	CARACTERÍSTICAS
	<ul style="list-style-type: none"> • Compuesto cerámico Ichimax • Excelente durabilidad • Libre de asbesto 100% • Diseño OEM • Incluye grasa lubricante sintética • OEM - 23326280

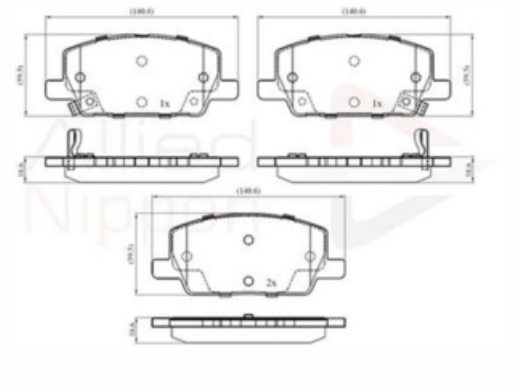
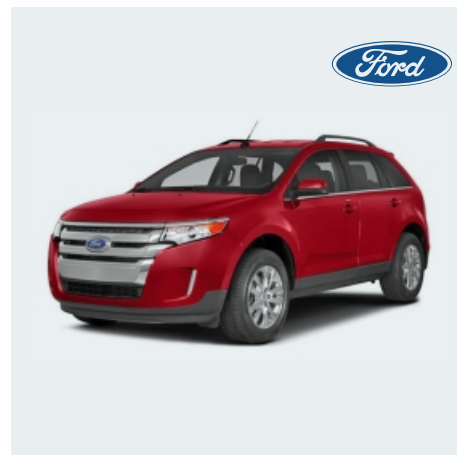
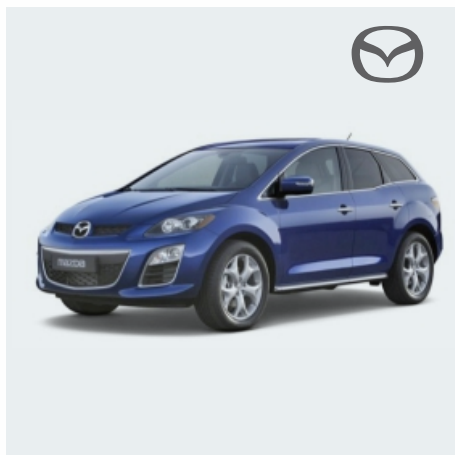

REFERENCIA	APLICACIÓN
 8377-D1258-FMSI-CM	FORD EDGE (2007-15) / MAZDA CX-7 (CX7L3T) 2.3cc 4X4 CX-9 (CX9CYV) 3.5cc / 3.7 V6 4X3 / MITSUBISHI ALL NEW MONTERO SPORT 2.5 (2020-) EJE DELANTERO

GRÁFICO	CARACTERÍSTICAS
	<ul style="list-style-type: none"> • Compuesto cerámico Ichimax • Excelente durabilidad • Libre de asbesto 100% • Diseño OEM • Incluye grasa lubricante sintética • OEM - L2Y6-33-28Z



REFERENCIA	APLICACIÓN
 9061-D1830-FMSI-CM	RENAULT NEW LOGAN / NEW SANDERO / NEW STEPWAY (2017-2021) EJE DELANTERO - PASTILLA GANCHO PEQUEÑO

GRÁFICO	CARACTERÍSTICAS
	<ul style="list-style-type: none"> • Compuesto cerámico Ichimax • Excelente durabilidad • Libre de asbesto 100% • Diseño OEM • Incluye grasa lubricante sintética • OEM-

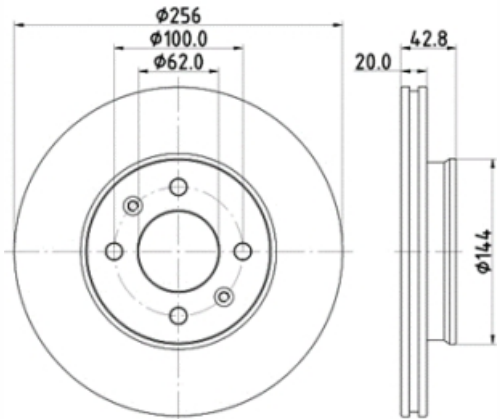

REFERENCIA	APLICACIÓN
 <p data-bbox="349 1010 544 1046">851712-G6300</p>	<p data-bbox="690 968 1312 1081">DISCO FRENO DELANTERO KIA PICANTO ALL NEW 1.248cc - VIBRANT / ZENITH GT AT / MT RIN 14" / RIN 15" DE LUJO</p>

GRÁFICO	CARACTERÍSTICAS
	<ul data-bbox="690 1393 1185 1542" style="list-style-type: none"> • Disco con recubrimiento seco Geomet • Excelente durabilidad • (Diam. Ext. 256 mm) 4 pernos • Diseño OEM